

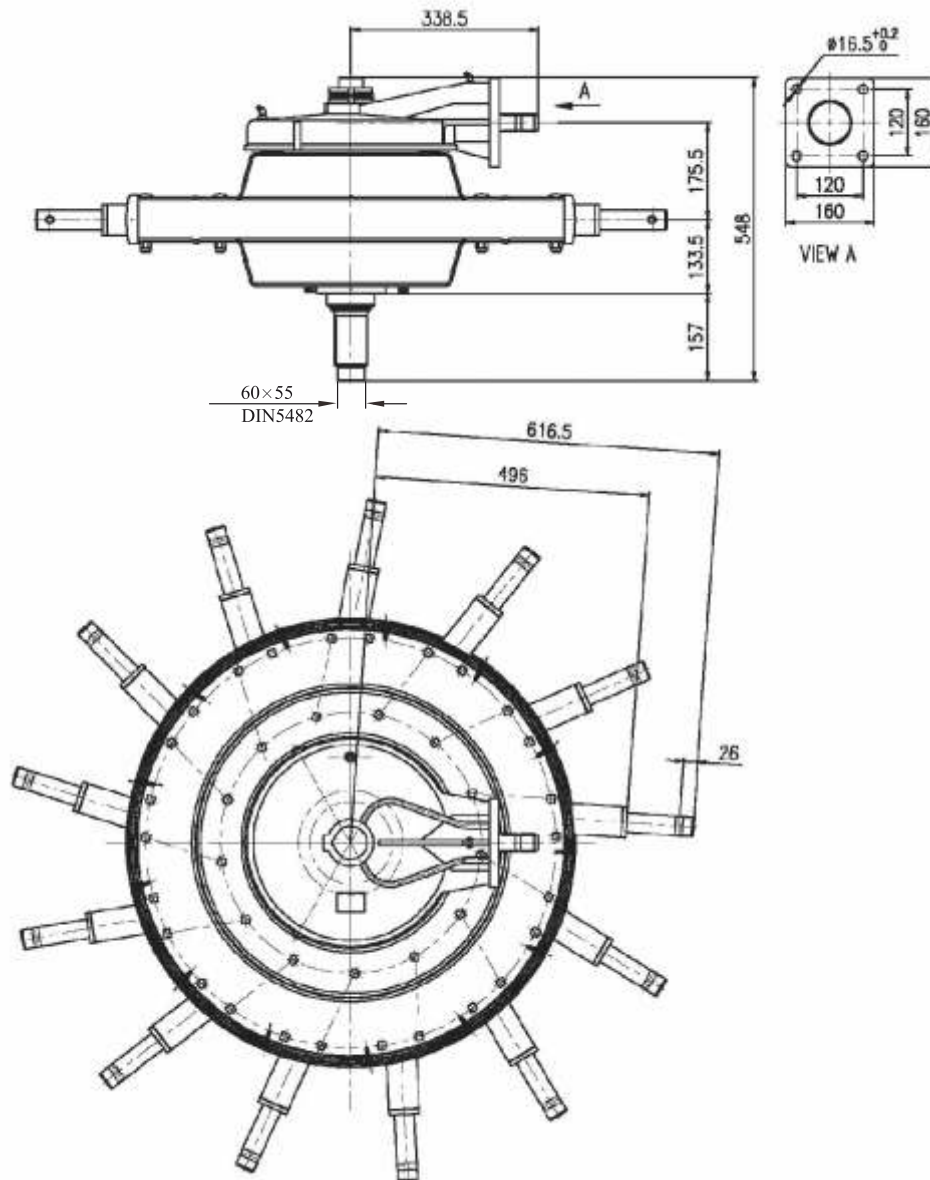



S-13



尺寸/Dimensions

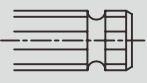

技术参数/Technical Data

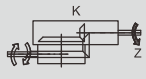
i						材料 Material	齿型 Toothing	 KG	 LT		
	输入转速 rpm input	输出转速 rpm output	千瓦(功率) Kw (HP)	输出扭矩 Nm(nom)	最大扭矩 Nm(max)					模 Module	旋转 Rotation
9,7:1	540	-	-	260	-	球铁 Ductile Iron GS400	格里森 螺旋伞齿 Gleason Helical Teeth	195	2.8	5	K